



WE STOCK 1/4" & 3/8" THICKNESS OUTSIDE CORNER HARDWARE  
VARIOUS 1/4" INTERNAL HARDWARE  
ALL OUR CONNECTIONS TAKE 1" DIAMETER CONNECTING PIN OR BOLT



OVERHEAD AND A SIDE VIEW OF A FLOAT TO FLOAT CONNECTION  
6H407EH & 6H408EH



90° JOIST STIFFENER PLATE (6H414)  
USED FOR BOTTOM SKID PLATE  
ATTACHMENT



EXTRA LONG MALE CORNER  
PLATES (6H407EH1) &  
INSIDE CORNER (6H411)



3/8" EXTRA LONG CORNER PLATE  
(6H497)



INSIDE CORNER (6H411) & 90° STIFFENER  
PLATE (6H414)



# 1/4" Standard Hardware

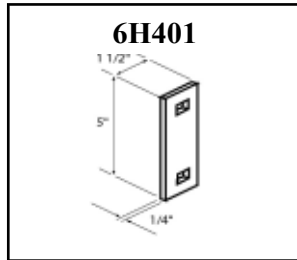

## Small Backer Plate

Weight: .55 Lbs

Size: 1 1/2" x 1/4" x 5"

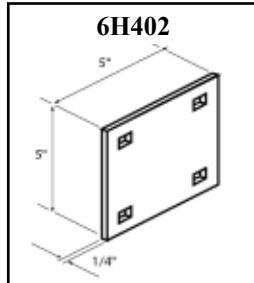

## Backer Plate

Weight: 1.80 Lbs

Size: 5" x 1/4" x 5"

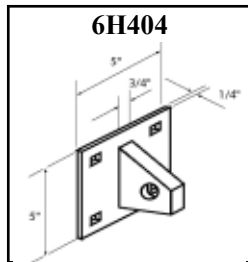

## T-Hinge Plate 1 Tab (Male)

Weight: 3.50 lbs

Size: 5" x 5"

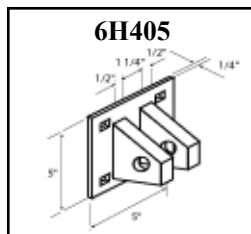

## T-Hinge Plate 2 Tab (Female)

Weight: 4.05 lbs

Size: 5" x 5"

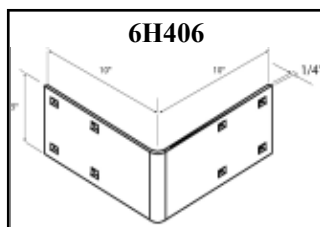

## Corner Plate No Tab

Weight: 7.30 lbs

Size: 5" x 10" x 10"

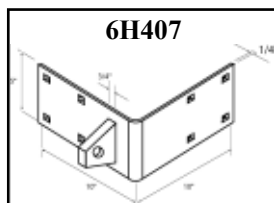

## Corner Hinge Plate 1 Tab (Male)

Weight: 8.95 lbs

Size: 5" x 10" x 10"



# 1/4" Standard Hardware

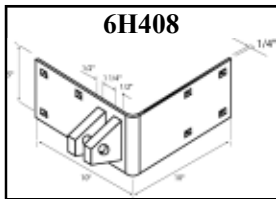

## Corner Hinge Plate 2 Tab (Fem)

Weight: 9.50 lbs.

Size: 5" x 10" x 10"

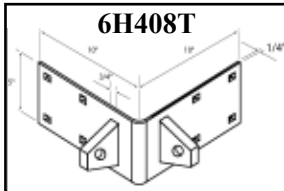

## Corner Hinge Plate 2 Tab (Male)

Weight: 10.65 lbs.

Size: 5" x 10" x 10"

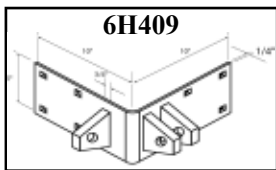

## Corner Hinge Plate 3 Tab (M&F)

Weight: 11.20 lbs.

Size: 5" x 10" x 10"

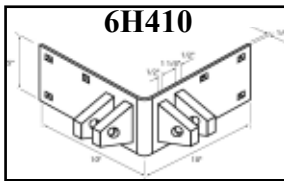

## Corner Hinge Plate 4 Tab (F & F)

Weight: 11.75 lbs.

Size: 5" x 10" x 10"

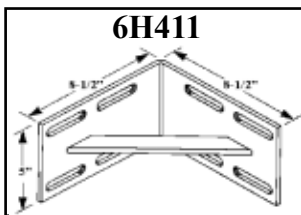

## 6H411 Inside Corner

Weight: 6.80 lbs.

Size: 5" x 8 3/4"

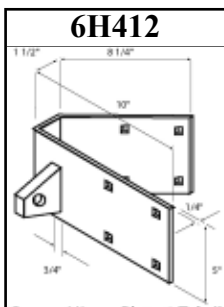

## 45° Corner Hinge Plate 1 Tab (Male)

Weight: 8.95 lbs

Size: 5" x 10" x 1 1/2" x 8 3/4"

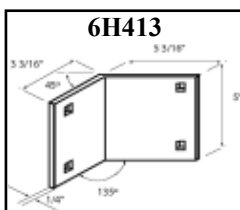

## 45° Stiffener Plate

Weight: 2.9 lbs.

Size: 5" x 3 3/16" x 5 3/16"



# 1/4" Standard Hardware

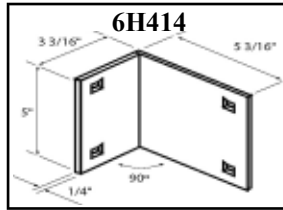

## 90° Stiffener Plate

Weight: 2.90 lbs.

Size: 5" x 3 3/16" x 5 3/16"

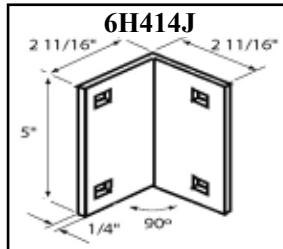

## Jr. 90° Stiffener Plate

Weight: 1.80 lbs.

Size: 5" x 2 11/16" x 2 11/16"

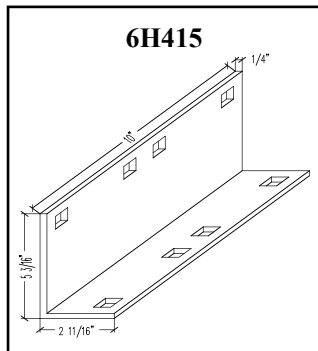

## Parallam Joist Stiffener

Weight: 3.20 lbs.

Size: 10" x 5 3/16" x 2 11/16"

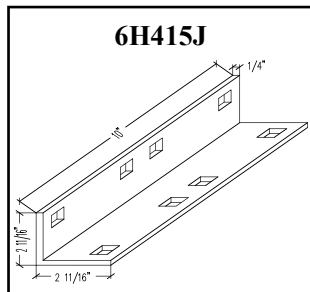

## Jr. Parallam Joist Stiffener

Weight: 5.40 lbs.

Size: 10" x 2 11/16" x 2 11/16"

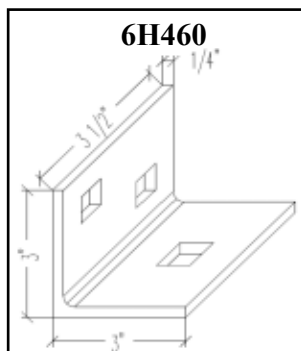

## Beam Clip

Weight: 1.20 lbs.

Size: 3 1/2" x 3" x 3"

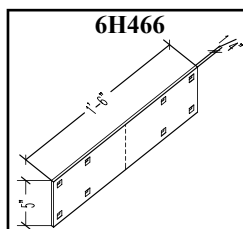

## Low Profile Splice Plate

Weight: 6 lbs.

Size: 18" x 1/4" x 5"



# 1/4" Standard Hardware

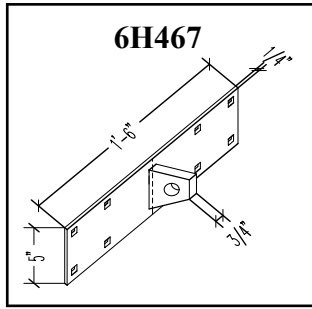

## Low Profile Splice Plate 1 Tab (M)

Weight: 7.6 lbs.

Size: 18" x 1/4" x 5"

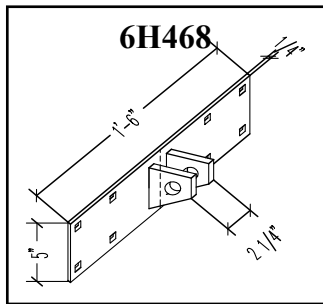

## Low Profile Splice Plate 2 Tab (F)

Weight: 8 lbs.

Size: 18" x 1/4" x 5"

## PIN OPTIONS ARE SOLD AS KITS

### 6H430



Short T-Pin

1" Dia x 3 1/2"

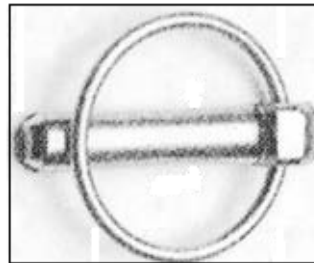

Zinc Plated Lynch Pin  
1/4" x 1 7/16"



1" Galvanized  
Flat Washer

### 9H500

Weight:

Size:

### 3 1/2" Hinge Bolt w/ Nylock Nut

Weight: 1.2 lbs.

Size: 1" x 3 1/2"

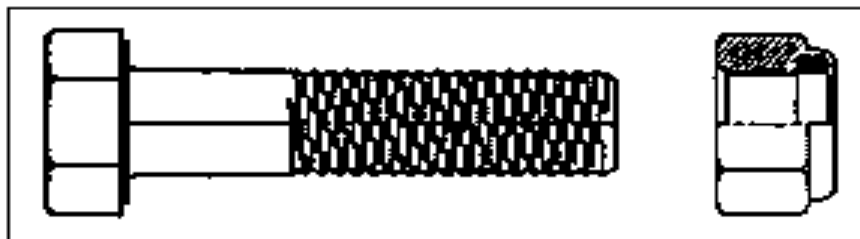



# 1/4" Extra Long Hardware

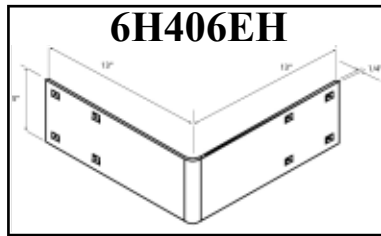

## Corner Hinge Ex. Long No Tab

Weight: 9.25 lbs.

Size: 5" x 13" x 13"

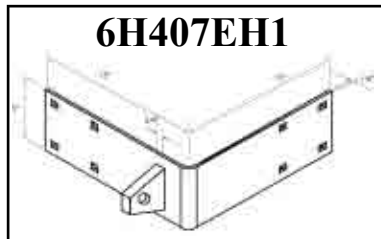

## Corner Hinge Ex. Long 1 Tab (M)

Weight: 10.60 lbs.

Size: 5" x 13" x 13"

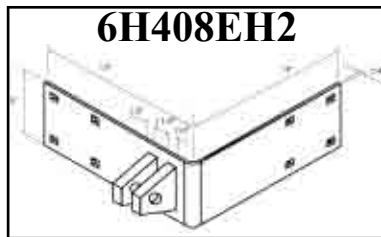

## Corner Hinge Ex. Long 2 Tab (F)

Weight: 11.10 lbs.

Size: 5" x 13" x 13"

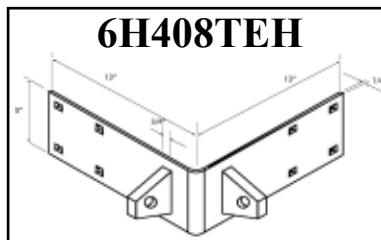

## Corner Hinge Ex. Long 1 Tab (M)

Weight: 9.25 lbs.

Size: 5" x 13" x 13"

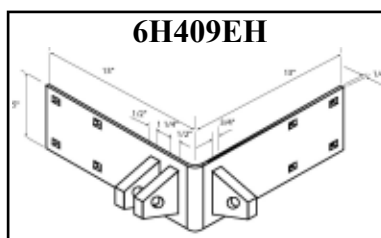

## Corner Hinge Ex. Long 3 Tab (M&F)

Weight: 9.25 lbs.

Size: 5" x 13" x 13"

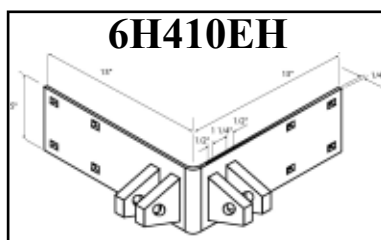

## Corner Hinge Ex. Long 4 Tab (F&F)

Weight: 9.25 lbs.

Size: 5" x 13" x 13"



# 3/8" Extra Long Hardware

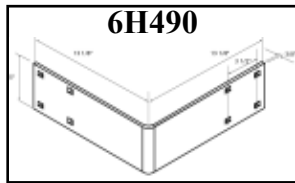

## 3/8" Corner Hinge Plate No Tab

Weight: 13.60 lbs.

Size: 5" x 13 1/8" x 13 1/8"

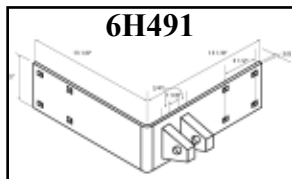

## 3/8" Corner Hinge Plate 2 Tab (Male)

Weight: 16.80 lbs.

Size: 5" x 13 1/8" x 13 1/8"

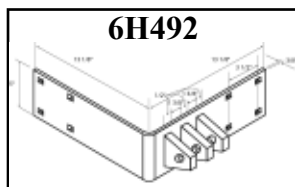

## 3/8" Corner Hinge Plate 3 Tab (Female)

Weight: 16.80 lbs.

Size: 5" x 13 1/8" x 13 1/8"

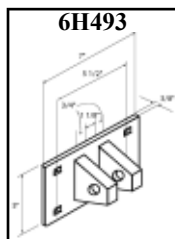

## 3/8" Male T-Hinge Plate 2 Tab

Weight: 6.60 lbs.

Size: 5" x 7"

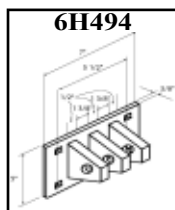

## 3/8" Female T-Hinge Plate 3 Tab

Weight: 6.60 lbs.

Size: 5" x 7"

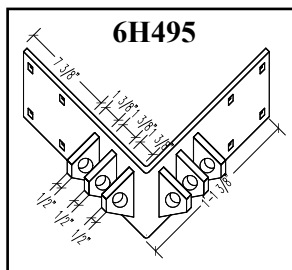

## 3/8" Corner Hinge Plate 6 Tab (Female)

Weight: 20.40 lbs.

Size: 5" x 13 1/8" x 13 1/8"

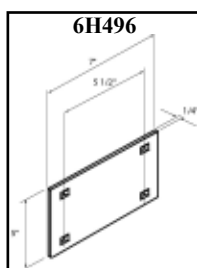

## Backer Plate

Weight: 2.40 lbs

Size: 1/4" x 5" x 7"



# **3/8" Extra Long Hardware**

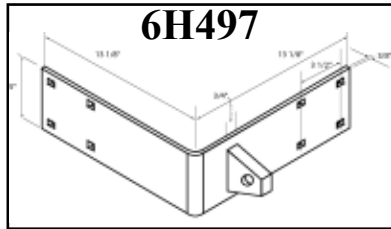

**3/8" Corner Hinge Plate 1 Tab**

Weight: 15.00 lbs.

Size: 5" x 13 1/8" x 13 1/8"

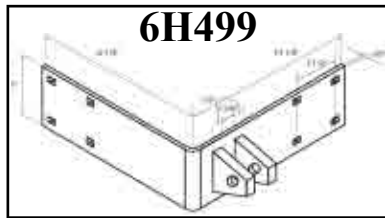

**3/8" Corner Hinge Plate 2 Tab**

Weight: 15.60 lbs.

Size: 5" x 13 1/8" x 13 1/8"

## **PIN OPTIONS ARE SOLD AS KITS**

### **6H498**

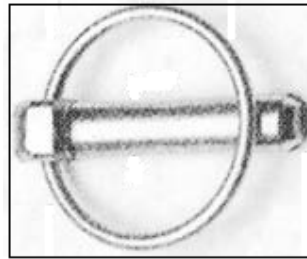

Zinc Plated Lynch Pin  
1/4" x 1 7/16"



1" Galvanized  
Flat Washer

**9H600 5 1/2" Hinge Bolt w/ Nylock Nut**

Weight: 1.80 lbs

Size: 1" x 5 1/2"

